



Link



pdf

COLLECTION 2014

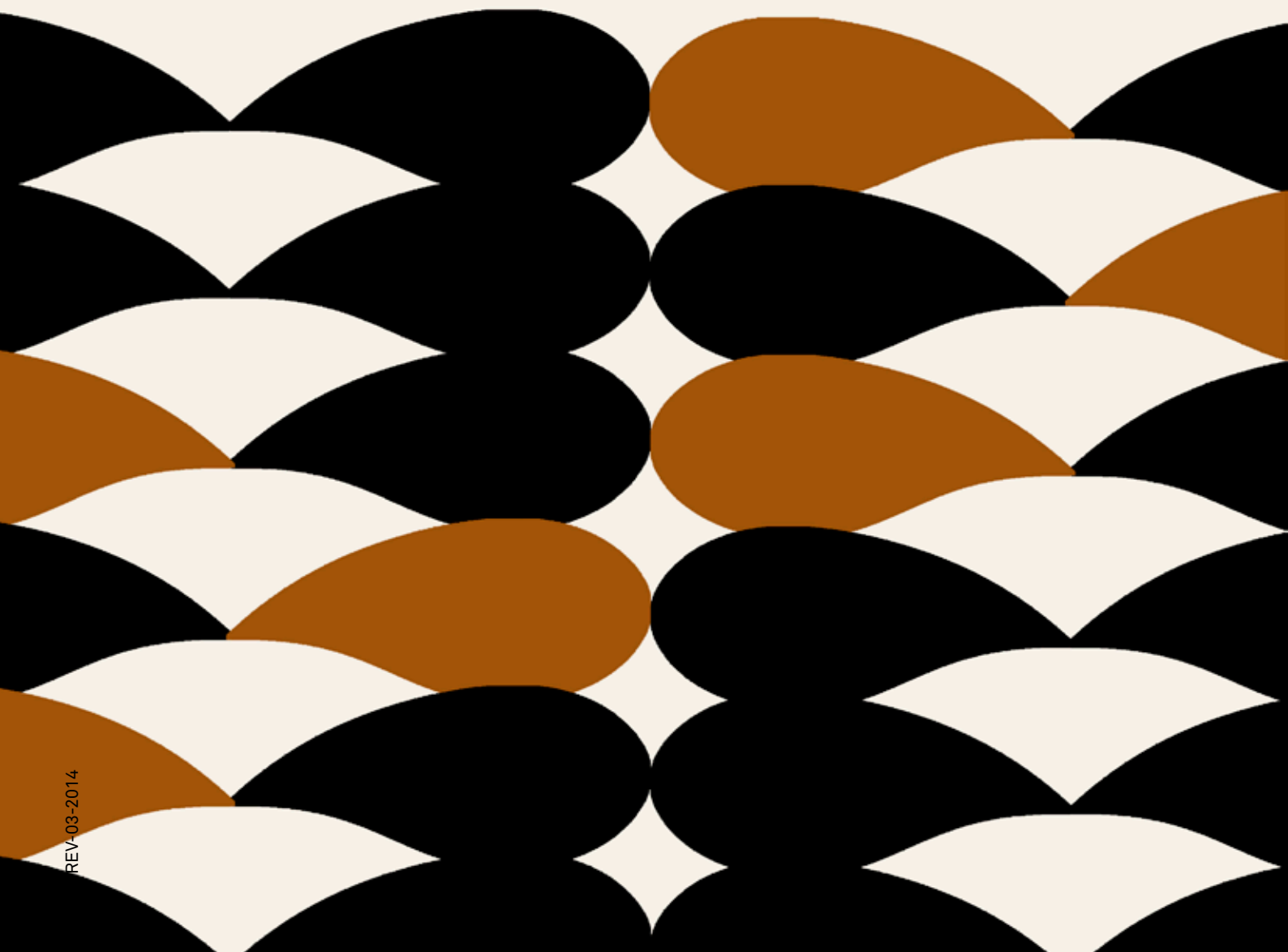



Ray Power

LINK. A cloud of light.

The LINK series, available as a suspension lamp in three versions and a floor lamp, was designed for LZF by the Irish designer Ray Power.

LINK makes beautiful use of wood veneer Möbius strips piled on top of one another, creating a stunning pattern which captivates the eye.

The lampshades are available in 11 different wood veneer finishes.

Home, contract, hospitality.

LINK. Nube de luz.

















El irlandés Ray Power ha diseñado para LZF la familia de lámparas LINK en sus tres versiones de suspensión y pie.

Está construida a partir de un conjunto de cintas de Moebius de chapa de madera que configuran un volumen hipnótico y relajante.

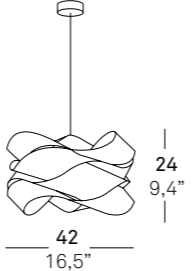
Pantallas disponibles en 11 acabados de chapa de madera diferentes.

















Home, contract, hospitality.

Link

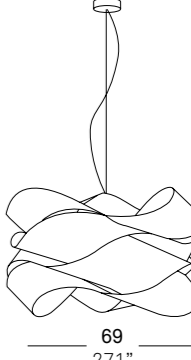
PENDANT SUSPENSIÓN	Info	Recommended bulbs Bombillas recomendadas	Packaging Embalaje	Dimensions/In Dimensiones/cm
LK SP	<p>THE FAMILY FAMILIA</p> <p>Pendant & floor Suspensión & pie</p> <p>Awards Premios</p> <p> Chicago 2008</p> <p>DESIGN PLUS Frankfurt 2007</p> <p>Certificates Certificados</p> <p>   </p> <p>Wood shade colors Acabados madera natural</p> <p></p> <p>Bulbs Not included Bombilla No incluida</p> <p>Metal canopy Brushed nickel ø 6 cm / ø 4,8" (USA) Florón metálico Acabado níquel ø 6 cm</p> <p>Electrical cable Coaxial Transparent 2m / 8 ft drop Cable eléctrico Transparente Coaxial 2 m</p> <p>Steel cable USA - 8 ft drop</p> <p>DESIGNER DISEÑADOR Ray Power</p>	<p>E-27</p> <ul style="list-style-type: none">  CFL globe ø 98 Bajo consumo 1 x 23 w or / o  CFL globe ø 120 Bajo consumo 1 x 15 w DIM¹ or / o  LED globe ø 92 Globo LED ø 92 1 x 14 w DIM¹ <p>¹Requires a dial or switch dimmer Requiere un potenciómetro o pulsador de regulación</p> <p>Class II </p>	<p>Box size Tamaño caja 50x50x30 cm</p> <p>Volume Volumen 0,075 m³</p> <p>Weight Peso Gross Bruto 2,2 Kg Net Neto 0,9 Kg</p>	 <p>42 16,5"</p> <p>24 9,4"</p>
			<p>Box size 20x20x12"</p> <p>Weight Gross 4,9 Lb Net 1,9 Lb</p>	
	<p>USA & CANADA</p> <p>Medium Base</p> <ul style="list-style-type: none">  CFL Globe 1 x 15 w max. or  LED Globe 1 x 9,5 w or  G-25 Incandescent 1 x 100 w max. <p>GU-24 Base Up-Charge Option</p> <ul style="list-style-type: none">  CFL Globe 1 x 15 w or  LED A-19 1 x 7 w max. 			



Link

PENDANT SUSPENSIÓN	Info	Recommended bulbs Bombillas recomendadas	Packaging Embalaje	Dimensions/In Dimensiones/cm
LK SG	<p>THE FAMILY FAMILIA</p> <p>Pendant & floor Suspensión & pie</p> <p>Awards Premios</p> <p> Chicago 2008</p> <p>DESIGN PLUS Frankfurt 2007</p> <p>Certificates Certificados</p> <p>   </p> <p>Wood shade colors Acabados madera natural</p> <p></p> <p>Bulbs Not included Bombilla No incluida</p> <p>Metal canopy Brushed nickel ø 12 cm / ø 4,8" Florón metálico Acabado níquel ø 12 cm</p> <p>Electrical cable Transparent 2 m / 8 ft drop Cable eléctrico Transparente 2 m.</p> <p>Steel cable 2 m / 8 ft drop Cable de acero 2 m.</p> <p>DESIGNER DISEÑADOR Ray Power</p>	<p>E-27</p> <ul style="list-style-type: none">  CFL globe ø 98 Bajo consumo 1 x 23 w or / o  CFL globe ø 120 Bajo consumo 1 x 15 w DIM¹ or / o  LED globe ø 92 Globo LED ø 92 1 x 14 w DIM¹ <p>¹Requires a dial or switch dimmer Requiere un potenciómetro o pulsador de regulación</p> <p>Class II </p>		 <p>42 16,5"</p> <p>48 18,9"</p> <p>69 27,1"</p>
			<p>Box size Tamaño caja 75x75x40 cm</p> <p>Volume Volumen 0,225 m³</p> <p>Weight Peso Gross Bruto 4,9 Kg Net Neto 1,5 Kg</p>	
	<p>USA & CANADA</p> <p>Medium Base</p> <ul style="list-style-type: none">  CFL Globe 1 x 26 w max. or  LED Globe 1 x 9,5 w max. or  G-25 Incandescent 1 x 100 w max. <p>GU-24 Base Up-Charge Option</p> <ul style="list-style-type: none">  CFL Globe 1 x 26 w max. or  LED A-19 1 x 7 w max. 		<p>Box size 30x30x16"</p> <p>Weight Gross 10,7 Lb Net 3,2 Lb</p>	

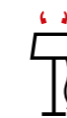

FAMILY / FAMILIA

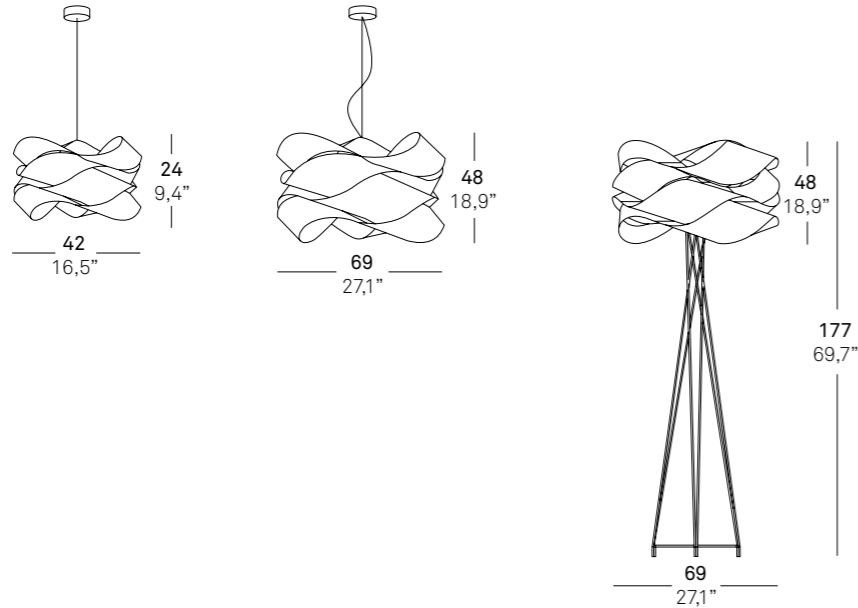

WOOD SHADE FINISHES / ACABADOS PANTALLAS

Natural timber veneer / Madera natural

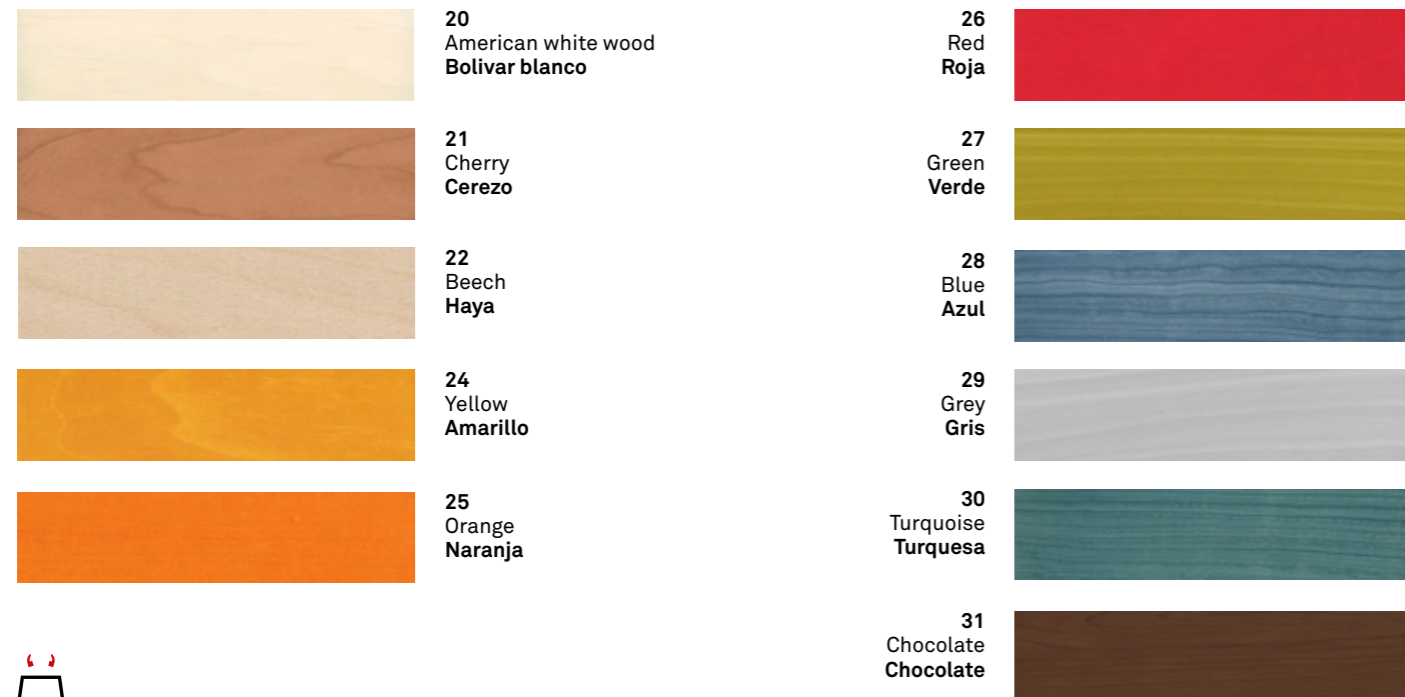

FLOOR PIE

LK P



Info

THE FAMILY FAMILIA

Pendant & floor Suspensión & pie

Awards Premios



Chicago 2008

DESIGN PLUS Frankfurt 2007

Certificates Certificados



Wood shade colors Acabados madera natural



Bulbs Not included Bombilla No incluida

Base

Chrome Base Cromada

Required Shade to base mount Requiere Montaje de pantalla a base

Cord and plug with on/off switch or dimming regulator Transparente 54"

Cable eléctrico y enchufe con interruptor de encendido/apagado o regulador de intensidad Transparente

DESIGNER DISEÑADOR Ray Power

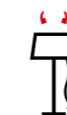

Recommended bulbs Bombillas recomendadas

E-27

- CFL globe ø 98 Bajo consumo 1 x 23 w or / o
- CFL globe ø 120 Bajo consumo 1 x 15 w DIM or / o
- LED globe ø 92 Globo LED ø 92 1 x 14 w DIM

Class II

Packaging Embalaje

Shade, box 1 Pantalla, caja 1

Box size Tamaño caja 75x75x40 cm

Volume Volumen 0,225 m³

Weight Peso 4,4 Kg

Foot, box 2 Pie, caja 2

Box size Tamaño caja 50x50x160 cm

Volume Volumen 0,400 m³

Weight Peso 6 Kg

Total Weight Peso Total Gross Bruto 10,4 Kg Net Neto 3,3 Kg

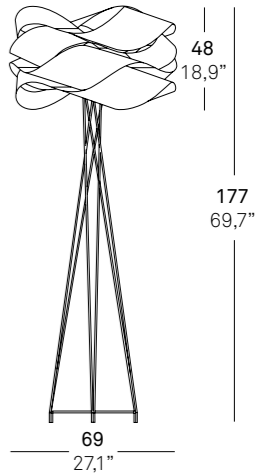

USA & CANADA

Medium Base

- CFL Globe 1 x 26 w max. or LED Globe 1 x 9,5 w max. or G-30 Incandescent 1 x 100 w max.

GU-24 Base Up-Charge Option

- CFL Globe 1 x 26 w max. or LEDA-19 1 x 7 w max.

Shade, box 1

Box size 30x30x16"

Weight 11 Lb

Foot, box 2

Box size 20x20x63"

Total Weight Gross 22,9 Lb Net 7,2 Lb











SPANISH
ARTISAN
OF THE YEAR
AWARD 2011



Branding
Award winner 2013



reddot design award
communication design
Branding Et Sound
Awards winner 2013